

# Regency (10202) Specification Sheet

Project Name:	Location:	MFG: Philips Lighting
Fixture Type:	Catalog No.:	Qty:

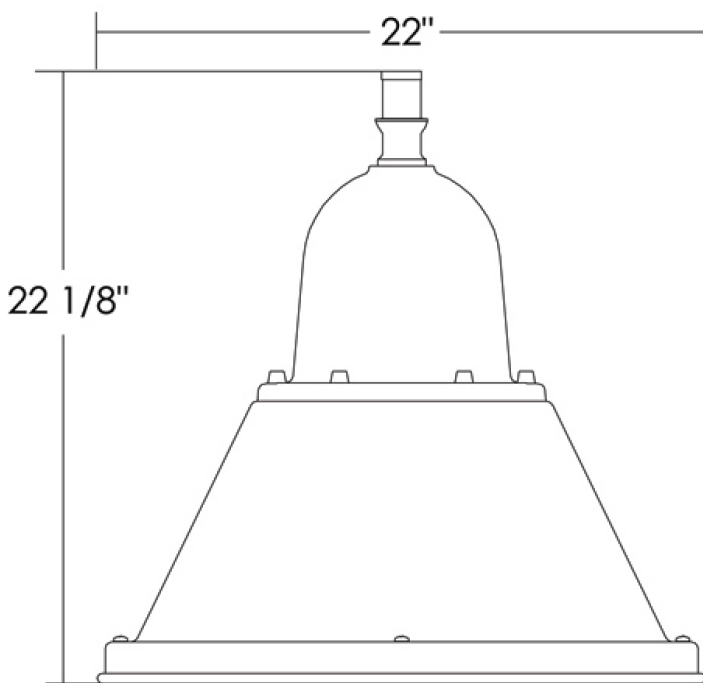

## Ordering Guide

Example: 10202 ABS GF D 50H E R N

Product Code	10202	Regency	
<b>Finish</b>	ABS ACP ARD ASI BLK BRN BRZ FGN GRA IRN RBZ SRT VBZ VCP VGN VTC WBZ WHT	Antique Brass Antique Copper Antique Red Antique Silver Black Brown Bronze Forest Green Granite Ironstone Rustic Bronze Shadow Rust Verde Bronze Verde Copper Verde Vintage Copper Weathered Bronze White	
<b>Panel/Globe</b>	GF KL KS TS	Flat Glass Ribbed Acrylic Teardrop Acrylic Sag Textured Polycarbonate Sag	
<b>Socket</b>	D G L R	Medium Mogul LED Induction	
<b>Wattage/Source</b>	50H 70H 100H 150H 250H 35S 50S 70S 100S 150S 250S 200I 55R 85R 165R LED	50W MH 70W MH 100W MH 150W MH 250W MH 35W HPS 50W HPS 70W HPS 100W HPS 150W HPS 250W HPS 200W INC 55W Induction 85W Induction 165W Induction LED	*1     *2 *1,3 *3      *2 *1,3 *4 *4 *4 *4
<b>Voltage</b>	E F G H	120V 208V 240V 277V	
<b>Distribution</b>	R S T	Type II - Full Cutoff Optic Type III - Full Cutoff Optic Type V - Full Cutoff Optic	
<b>Photoeye</b>	N	None	

- \*1 Medium Base Only
- \*2 Mogul Base Only
- \*3 35W HPS and 200W INC (E) 120V Only
- \*4 Consult Factory

# Regency (10202) Specification Sheet

Project Name:	Location:	MFG: Philips Lighting
Fixture Type:	Catalog No.:	Qty:

## Specifications

### CONSTRUCTION:

Turned aluminum hang-straight. Spun aluminum shade. Cast aluminum ring. Cast aluminum hinged access door for easy relamping.

### FINISH:

Resilient TGIC thermoset polyester powdercoat paint is electrostatically applied to every fixture. Specially formulated for Philips Outdoor Lighting, it provides UV protection, and the highest temperature rating in the industry. In addition to the standard color choices shown, a spectrum of custom colors is available.

### PANELS/LENS/GLOBE:

See lenses for available options.

### LAMPING:

Lamp is not included.

### ELECTRICAL ASSEMBLY:

Lantern will be prewired and tested. All electrical components are ETL listed.

### BALLAST:

Ballast and component parts mounted inside cast aluminum moisture proof ballast compartment. (Contact factory for availability.)

### MOUNTING:

Fixture mounts to Hanover Lantern bracket arms. See accessories.

### WARRANTY:

Three-year limited warranty.

### CERTIFICATIONS:

ETL Listed to U.S. safety standards for wet locations. cETL Listed to Canadian safety standards for wet locations.

### Height:

22 1/8"

### Width:

22"

### EPA:

1.00

### Max. Weight:

25 lbs.