

Architectural Decorative, Corridor LED

Catalog number:

Notes:

Type:

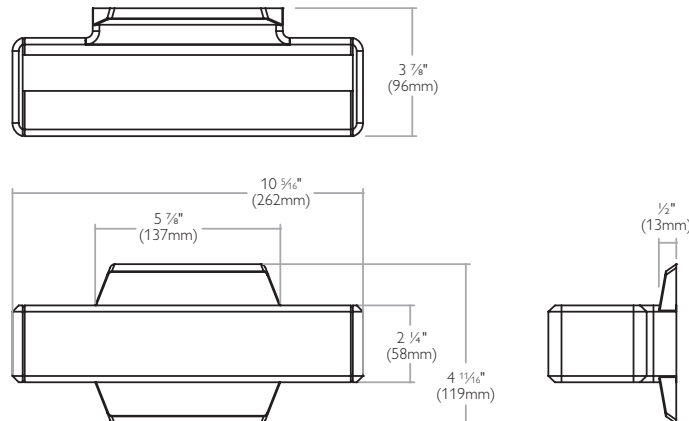

Ordering Information*

Catalog Number	Finish	CCT	Voltage	Wattage	Source Life
CDL27SAU	Satin Aluminum	2700K	120V/277V	36W	50,000 hours based on 70% lumen maintenance.
CDL27WHU	White				
CDL30SAU	Satin Aluminum	3000K	120V/277V		
CDL30WHU	White				
CDL35SAU	Satin Aluminum	3500K	120V/277V		
CDL35WHU	White				
CDL40SAU	Satin Aluminum	4000K	120V/277V		
CDL40WHU	White				

Accessory Options

Catalog No.	Description*
CDLS01	white sleeve straight accessory
CDLS02	white sleeve wave accessory
CDLA**	acrylic flat diffuser
CDLG**	glass flat diffuser

* The white sleeve accessories are paintable.
 ** The CDLA and/or CDLG must be used with either the CDLS01 or CDLS02 accessory.

* For a lower wattage alternative option replace the "U" with a "01" for the 120V (18W) option and a "02" for the 277V (18W) option. See alternate photometry on page 2.

Features

- Housing:** Extruded aluminum.
- End Caps:** Die-cast aluminum.
- LED board:** Two linear FR4 circuit boards, one up and one down, with 8 high brightness LED's each.
- Optical Assembly:** Remote phosphor technology provides increased efficiency and color stability. Phosphor lens assembly positioned in front of LED array converts blue light to white and produces a wide even pattern of diffused light without bright spots created by individual LEDs. Uniform phosphor coating provides consistent, stable color with a shift of no more than +/-100K over life. Mixing chamber redirects scattered light back out through the emitting aperture.
- Mounting Options:** Conduit or J-Box mounting available. J-Box cover accessories are shipped with the fixture.

Finish

Satin aluminum - Brushed and clear lacquer finish.
 White - Powder coat finish.

Electrical

Input Voltage	Input Frequency	Input Power	Efficacy	Input Current	THD	Power Factor
120V	50/60Hz	36W	*33lm/w	0.167 amp	<5%	>0.9
277V				0.072 amp		

* +/-8%

Dimming Capability:
 Use 0-10V type dimmer.
 Refer to LED-DIM Spec Sheet.
 For the 18W alternate option use ELV type dimming.

Labels

UL Listed, ADA compliant
 5 year warranty

Architectural Decorative, Corridor LED

CDL40SAU @ 36W

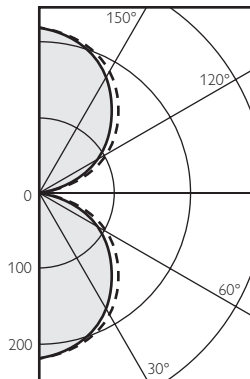

Report No.: F12034
 Luminaire Lumens: 1160 lm
 Input Watts: 36w
 Luminaire Efficacy: 32.2 lm/w
 CRI: 84
 Color Temp: 4000K*
 +/- 8%

Candlepower Summary

Angle	Along	45	Across	Output Lumens
0	219	219	219	
5	219	218	218	21
15	211	209	208	59
25	197	192	190	88
35	176	168	164	105
45	148	138	134	107
55	113	104	101	94
65	74	67	66	68
75	34	32	31	34
85	5	7	7	8
90	1	1	1	
95	4	5	5	6
105	33	27	26	30
115	74	65	61	65
125	114	104	99	94
135	148	139	135	108
145	176	169	165	106
155	195	191	188	88
165	209	206	206	58
175	216	216	216	21
180	217	217	217	

Zonal Lumens and Percentages

Zone	Lumens	%Fixt
0-30	168	14.52
0-40	274	23.61
0-60	475	40.96
0-90	585	50.45
40-90	311	26.84
60-90	110	9.49
90-180	575	49.55
0-180	1160	100.00

** Efficacy (lumens per watt) = 32.2 **
 *** THIS IS AN ABSOLUTE TEST ***

Tested using absolute photometry as specified in LM79: IESNA Approved Method for the Electrical and Photometric Measurements of Solid-State Lighting Products.

Lighting Power Density: 0.60 W/SF
ASHRAE 90.1 - 2010 corridor limit: 0.66 W/SF
Reflectances: 80% ceiling / 20% wall / 20% floor
 Initial Footcandles are on floor.

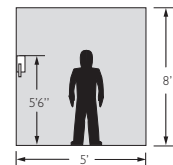
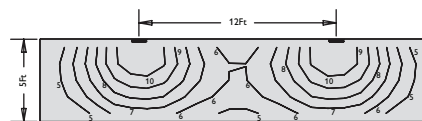

CDL3501SA @ 18W Alternate Option

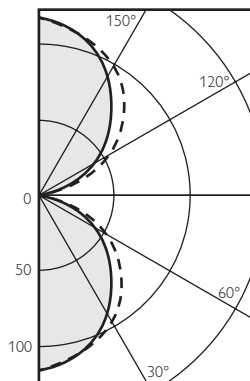

Report No.: F11203
 Luminaire Lumens: 617 lm
 Input Watts: 17.7 w
 Luminaire Efficacy: 34.9 lm/w
 CRI: 84
 Color Temp: 3500K*
 +/- 8%

Candlepower Summary

Angle	Along	45	Across	Output Lumens
0	114	114	114	
5	113	113	113	11
15	110	109	109	31
25	102	102	101	46
35	92	91	89	56
45	78	76	74	58
55	60	58	56	50
65	40	38	36	36
75	19	17	16	17
85	3	3	3	4
90	0	0	0	
95	2	2	2	3
105	18	16	15	16
115	40	37	35	35
125	61	58	56	50
135	79	77	75	58
145	94	93	91	57
155	105	104	103	47
165	112	112	111	31
175	116	116	116	11
180	117	117	117	

Zonal Lumens and Percentages

Zone	Lumens	%Fixt
0-30	88	14.29
0-40	144	23.35
0-60	252	40.86
0-90	309	50.07
40-90	165	26.71
60-90	57	9.21
90-180	308	49.93
0-180	617	100.00

** Efficacy (lumens per watt) = 34.9 **
 *** THIS IS AN ABSOLUTE TEST ***

Tested using absolute photometry as specified in LM79: IESNA Approved Method for the Electrical and Photometric Measurements of Solid-State Lighting Products.

Lighting Power Density: 0.30 W/SF
ASHRAE 90.1 - 2010 corridor limit: 0.66 W/SF
Reflectances: 80% ceiling / 50% wall / 20% floor
 Initial Footcandles are on floor.

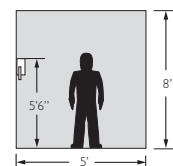
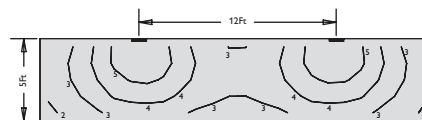

Philips Lightolier
 e: lol.webmaster@philips.com
 t: (508) 679-8131
 w: www.lightolier.com

CDL June 6, 2012

Specifications are subject to change without notice.
 © Koninklijke Philips Electronics N.V., 2012. All rights reserved.