

Complete ordering instructions on back.

Sample Run, End Plate and Corner Block Accessories

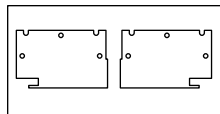

End Cap Set
PTS7EP Standard
PTS7EPA Air

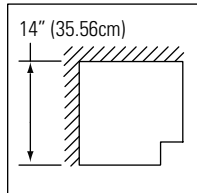
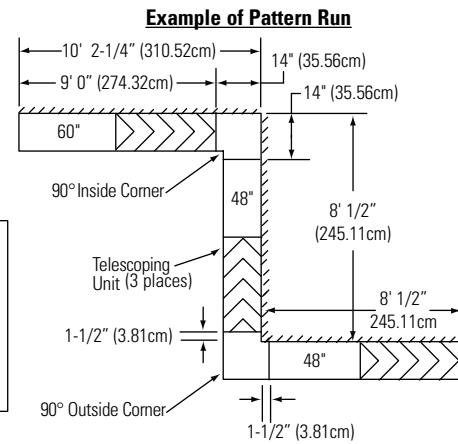
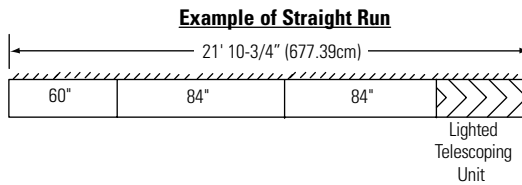

90° Inside
PTS7C901 Standard
PTS7C901A Air

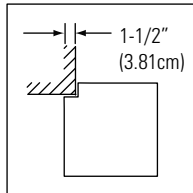

90° Outside
PTS7C900 Standard
PTS7C900A Air

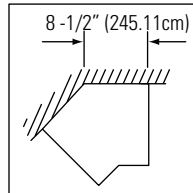

135° Inside
PTS7C1351 Standard
PTS7C1351A Air

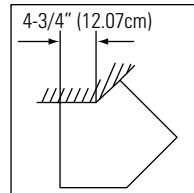

135° Outside
PTS7C1350 Standard
PTS7C1350A Air

Features

- Housing:** Die-formed steel, slotted for air return. Integral flanges at each end strengthen the housing and permit housings to be bolted together in continuous runs and facilitate suspension of fixture. Concealed openings for heat extraction and air return.
- Lamping:** One T8 fluorescent lamp, as specified. Provided by others.
- Reflector:** Die-formed semi-specular aluminum.
- Louver:** Semi-specular anodized aluminum, 40° lengthwise by 30° minimum crosswise shielding. Supported along both edges by concealed frame of extruded aluminum. Bold baffle, prismatic lens, gold anodized louver, open or egg crate louver available, consult factory.
- Socket Channels:** Die-formed, pre-painted steel held by support brackets and allows for up to 6" (15.24cm) lamp overlap.
- Ceiling Trim:** Extruded aluminum with integral aligner splines.

Electrical

Specify 120 volt or 277 volt. 3 conductor, 18 gauge wire. Color-coded quick connectors allow ease of connection for joiner modules. For special circuiting, consult factory. Factory installed ballast disconnect allows the ballast to be disconnected from and reconnected to incoming power under load without turning the entire circuit off.

Dimming: Advance Mark X, use Advance compatible two-wire control (no extra control lead required).

Mountings

Wall Adjustment Bracket - Allows for inconsistencies in wall straightness. Die-formed steel used to mount system to the wall.

Finish

Ceiling trim painted baked enamel semi-gloss white.

Options and Accessories

90° inside, 90° outside, 135° inside, and 135° outside corners available.

Labels

UL, cUL and I.B.E.W.

Job Information	Type:
Job Name:	
Cat. No.:	
Lamp(s):	
Notes:	

Performance & Quick Calculators

CANDLEPOWER CURVE

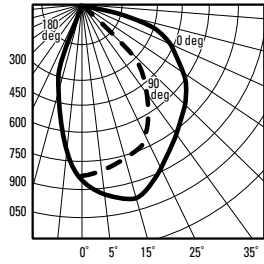

REPORT NO: LRL 499-5D
LAMPS: 1-F032T8
EFFICIENCY: 46.7%

CANDLEPOWER SUMMARY

ZONE	0	45	90	135	180
Deg	0	0	0	0	0
180	0	0	0	0	0
175	0	0	0	0	0
165	0	0	0	0	0
155	0	0	0	0	0
145	0	0	0	0	0
135	0	0	0	0	0
125	0	0	0	0	0
115	0	0	0	0	0
105	0	0	0	0	0
95	0	0	0	0	0
90	0	0	0	0	0
85	39	15	2	2	2
85	153	90	5	3	3
75	440	120	13	8	9
65	560	338	79	34	14
55	669	532	288	64	32
45	754	705	512	103	55
35	885	833	677	225	104
25	969	949	778	386	285
15	950	920	837	704	620
0	833	833	833	833	833

COEFFICIENTS OF UTILIZATION

% EFFECTIVE CEILING CAVITY REFLECTANCE

ROOM CAVITY RATIO	% WALL REFLECTANCE								
	80			70			50		
	50	30	10	50	30	10	50	30	10
0	56	56	56	54	54	54	52	52	52
1	50	49	47	49	48	46	47	46	45
2	45	43	41	44	42	40	43	41	39
3	41	38	35	40	37	35	39	36	34
4	37	34	31	36	33	31	35	33	30
5	33	30	27	33	30	27	32	29	27
6	30	27	24	30	27	24	29	26	24
7	28	24	21	27	24	21	27	24	21
8	25	21	19	25	21	19	24	21	19
9	23	19	17	22	19	17	22	19	17
10	21	17	15	21	17	15	20	17	15

ZONAL LUMEN SUMMARY

ZONE	LUMENS	% BARELAMP	% LUMINAIRE
0-90	1354	46.7	100.0
90-180	0	0.0	0.0
0-180	1354	46.7	100.0

Ordering Information

ONE LIGHT						
Cat No.	PTS7T148	PTS7184	PTS7160	PTS7148	PTS7136	PTS7124
Size	27" to 48"	84"	60"	48"	36"	24"
Lamps	1-4 Foot	2-4 Foot	2-3 Foot	1-4 Foot	1-3 Foot	1-2 Foot
Type	Tele	Module	Module	Module	Module	Module
4'3"-6'0"	1					1
5'3"-7'0"	1				1	
6'3"-8'0"	1			1		
7'3"-9'0"	1		1			
8'3"-10'0"	1			1		1
9'3"-11'0"	1	1				
10'3"-12'0"	1		1		1	
11'3"-13'0"	1	1				1
12'3"-14'0"	1	1			1	
13'3"-15'0"	1	1		1		
14'3"-16'0"	1	1	1			
15'3"-17'0"	1	1		1		1
16'3"-18'0"	1	2				
17'3"-19'0"	1	1	1		1	
18'3"-20'0"	1	2				1
19'3"-21'0"	1	2			1	
20'3"-22'0"	1	2		1		
21'3"-23'0"	1	2	1			1
22'3"-24'0"	1	2		1		1
23'3"-25'0"	1	3				
24'3"-26'0"	1	2	1		1	
25'3"-27'0"	1	3				1
26'3"-28'0"	1	3			1	
27'3"-29'0"	1	3		1		
28'3"-30'0"	1	3	1			
29'3"-31'0"	1	3		1		1
30'3"-32'0"	1	4				
31'3"-33'0"	1	3	1		1	
32'3"-34'0"	1	4				1
33'3"-35'0"	1	4			1	
34'3"-36'0"	1	4		1		
35'3"-37'0"	1	4	1			
36'3"-38'0"	1	4		1		1
37'3"-39'0"	1	5				
38'3"-40'0"	1	4	1		1	
39'3"-41'0"	1	5				1
40'3"-42'0"	1	5			1	
41'3"-43'0"	1	5		1		
42'3"-44'0"	1	5	1			
43'3"-45'0"	1	5		1		1
44'3"-46'0"	1	6				
45'3"-47'0"	1	5	1		1	
46'3"-48'0"	1	6				1
47'3"-49'0"	1	6			1	
48'3"-50'0"	1	6		1		
49'3"-51'0"	1	6	1			
50'3"-52'0"	1	6		1		1
51'3"-53'0"	1	7				
52'3"-54'0"	1	6	1		1	

Quick Calculators

ONE SIDE MOUNTING NO OPPOSITE WALL

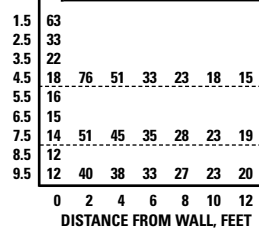

ONE SIDE MOUNTING 6 FT BETWEEN WALLS

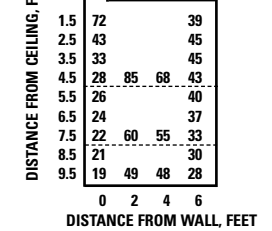

TWO SIDE MOUNTING 12 FT BETWEEN WALLS

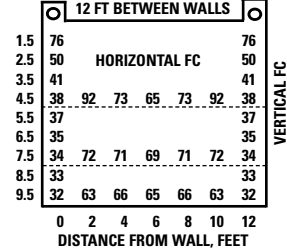

Ordering Instructions

Individual Fixtures:

- Order number of FIXTURES.
- Order one END PLATE SET per fixture.

Continuous Rows:

- Determine run length.
- Use chart above to find catalog numbers. Each run ends with a telescoping unit.
- Order END PLATE SET for each open run.

Square/Rectangle Patterns:

- Consult plans and mark locations for corners.
- Calculate net footage of each run.
- Deduct corner dimension from each corner.
- Determine catalog numbers the same way as a straight run.

NOTE: Add to end of catalog number for desired ballast.

E81 = T8 Electronic 120v

E82 = T8 Electronic 227v

M71 = T8 Electronic Dimming Ballast 120v

M72 = T8 Electronic Dimming Ballast 277v

Job Information	Type:
------------------------	--------------